

Medos 2018





Medos
SS



-N^o: 114SS30045

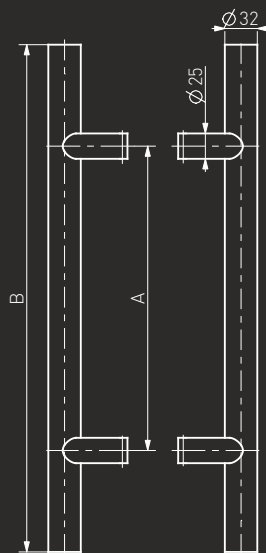

45°

90°

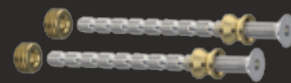
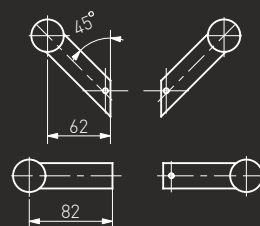

A	B
300	500
450	650
600	800
1200	1400
1300	1800

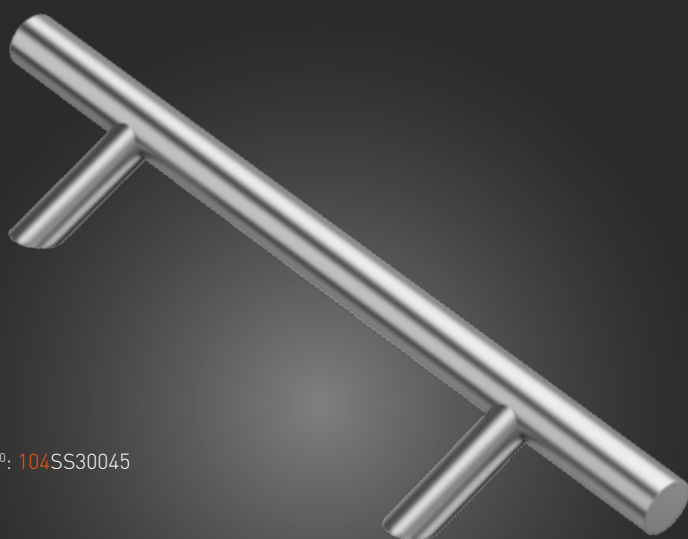

-N^o: 104SS30045

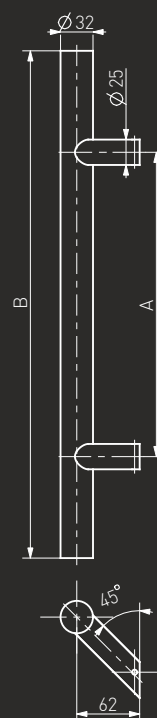

-N^o: 10400000000

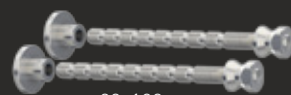

22-102mm

L	-N ^o
35	10400003500
45	10400004500
55	10400005500

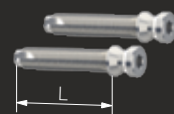

-N^o: 10400000012



Pochwył ze stali nierdzewnej "SS" (INOX)

Szczotkowany / Brushed / Brossée / Шлифованная

Pochwył drzwiowy / Pull handle / Barre de tirage / Офисная ручка

Medos
SP





-Nº: 114SP30045

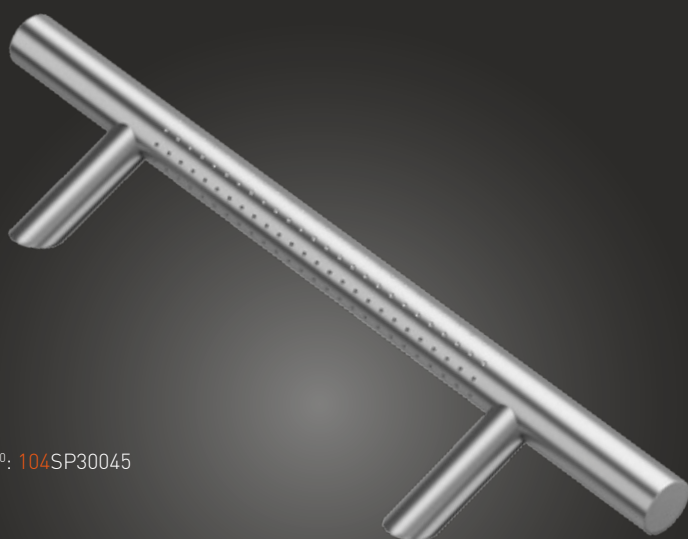
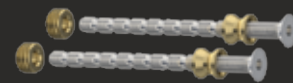
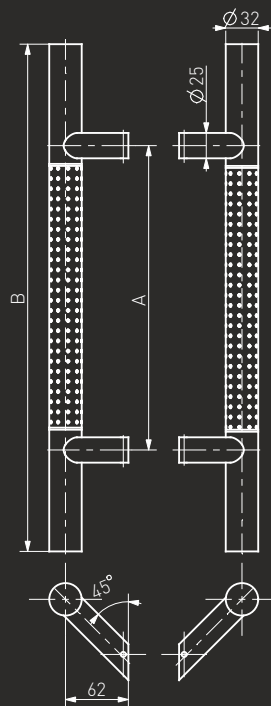

-Nº: 104SP30045

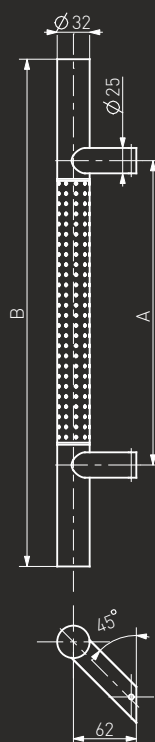

A	B
300	500
450	650
600	800
1200	1400

-Nº: 10400000000

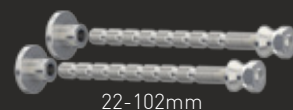

22-102mm

L	-Nº
35	10400003500
45	10400004500
55	10400005500

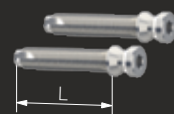

-Nº: 10400000012



Pochwyt ze stali nierdzewnej "SP" (INOX)

Nakrapiany / Spotted / Pointillée / С фрезерованной поверхностью в виде точек

Pochwyt drzwiowy / Pull handle / Barre de tirage / Офисная ручка



Medos
CS



-Nº: 114CS30045

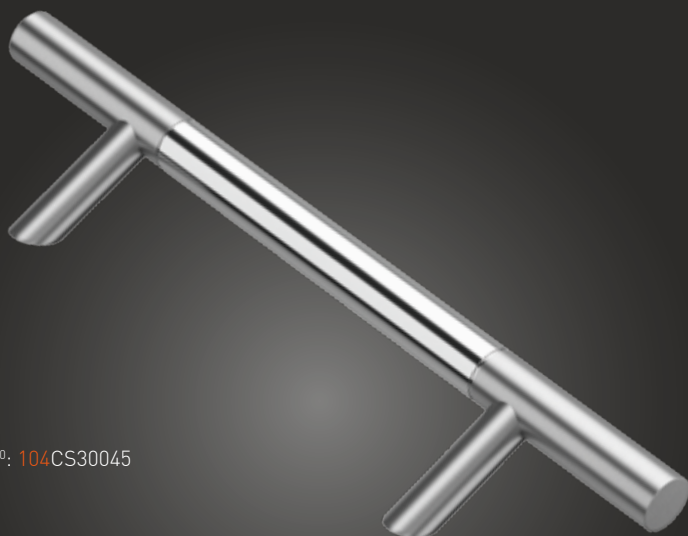
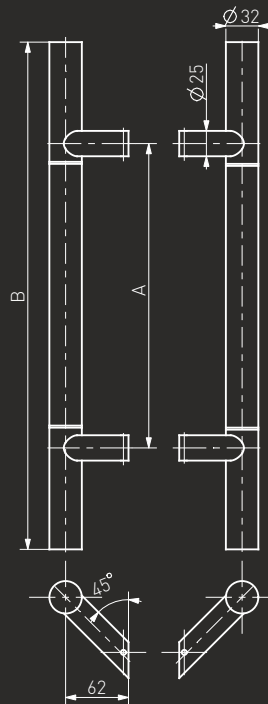

-Nº: 104CS30045

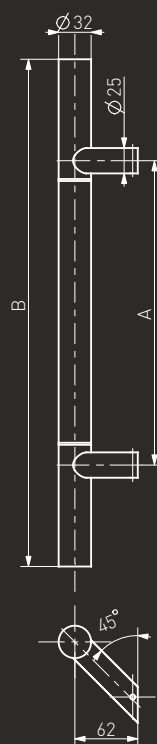

A	B
300	500
450	650
600	800
1200	1400



-Nº: 10400000000

22-102mm

L	-Nº
35	10400003500
45	10400004500
55	10400005500

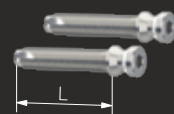

-Nº: 10400000012



Pochwyt ze stali nierdzewnej "CS" (INOX)

Szczotkowany/polerowany / Brushed/polished / Brossée/polie / Шлифованная/полированная

Pochwyt drzwiowy / Pull handle / Barre de tirage / Офисная ручка



Medos
MA

-N^o: 114MA30045

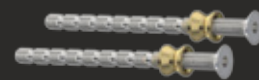
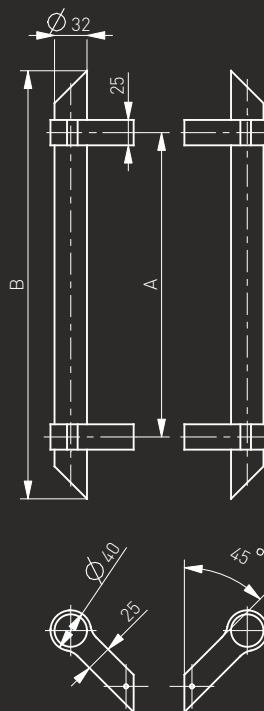
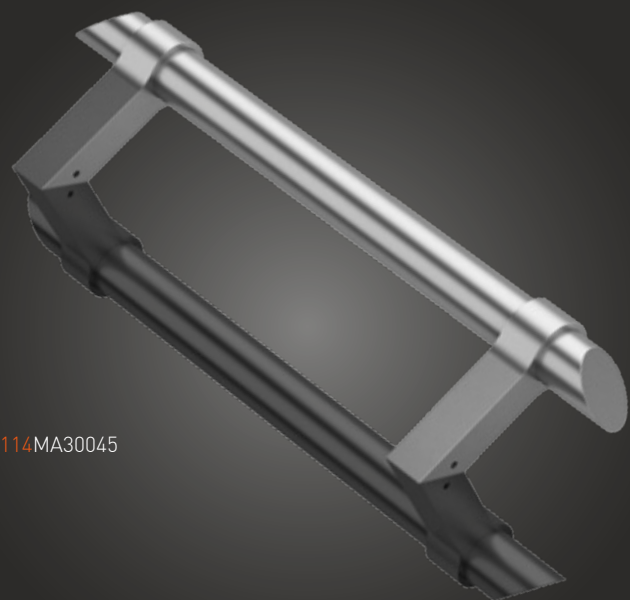

A	B
300	422
450	572
600	722
1200	1322

-N^o: 104MA30045

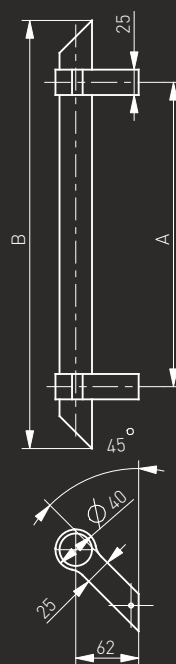
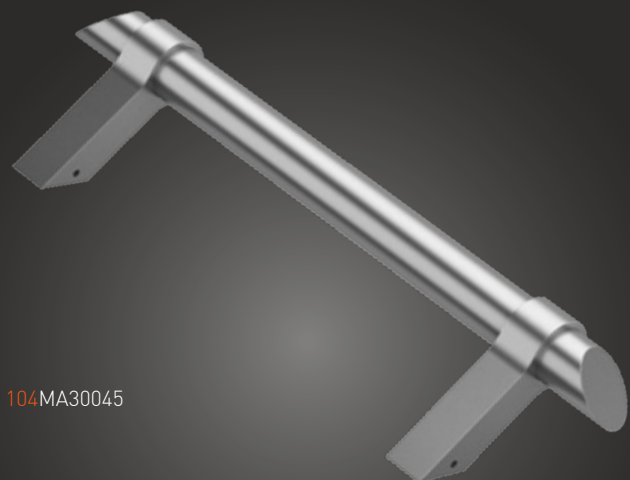

-N^o: 10400000000

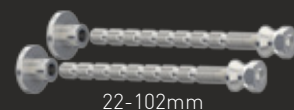

22-102mm

L	-N ^o
35	10400003500
45	10400004500
55	10400005500

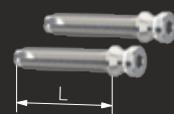

-N^o: 10400000012



Pochwył ze stali nierdzewnej "MA" (INOX)

Szczotkowany / Brushed / Brossée / Шлифованная

Pochwył drzwiowy / Pull handle / Barre de tirage / Офисная ручка



Medos

SE



-Nº: 114SE30045

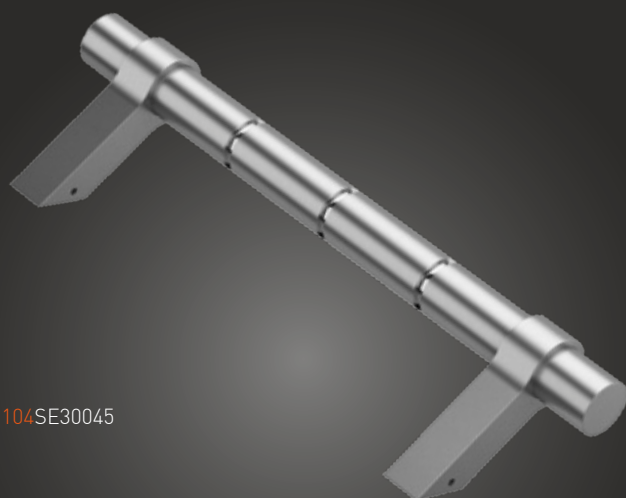
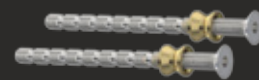
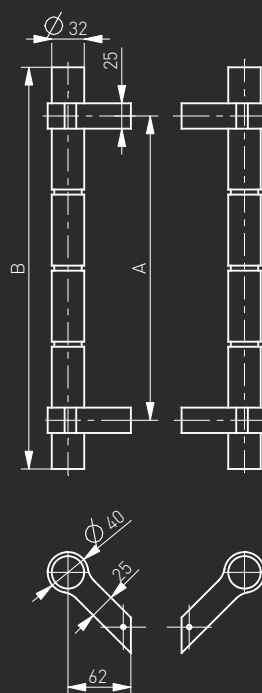

-Nº: 104SE30045

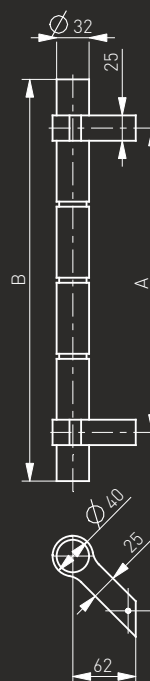

A	B
300	396
600	696
1200	1296



-Nº: 10400000000

22-102mm

L	-Nº
35	10400003500
45	10400004500
55	10400005500

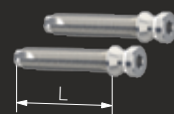

-Nº: 10400000012



Pochwył ze stali nierdzewnej "SE" (INOX)

Szczotkowany / Brushed / Brossée / Шлифованная

Pochwył drzwiowy / Pull handle / Barre de tirage / Офисная ручка



Medos
WB



-Nº: 114WB30045

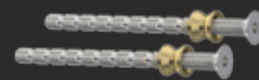
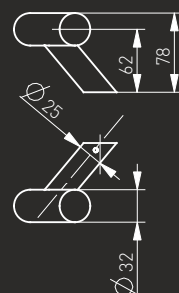
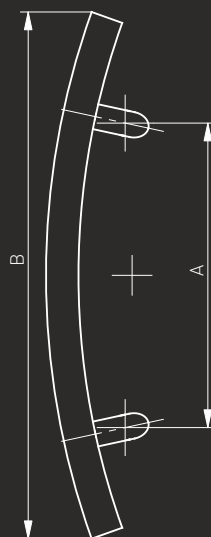

A	B
300	519
560	802

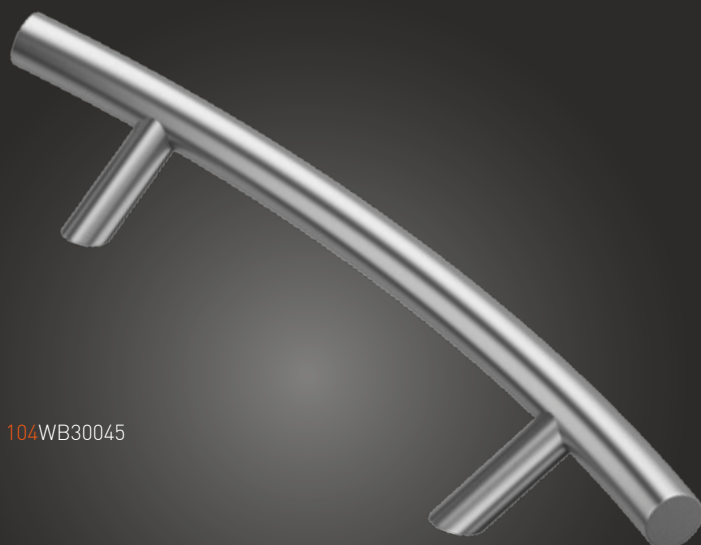

-Nº: 104WB30045

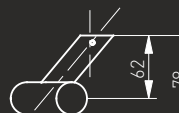
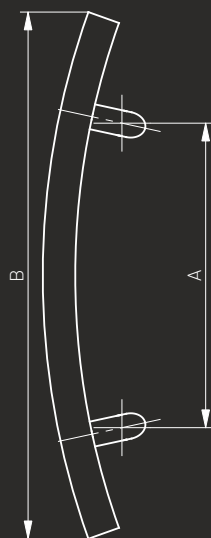

-Nº: 10400000000

22-102mm

L	-Nº
35	10400003500
45	10400004500
55	10400005500

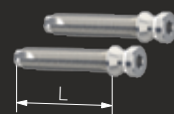

-Nº: 10400000012



Pochwył ze stali nierdzewnej "WB" (INOX)

Szczotkowany / Brushed / Brossée / Шлифованная

Pochwył drzwiowy / Pull handle / Barre de tirage / Офисная ручка

Medos
CW



-Nº: 114CW30090

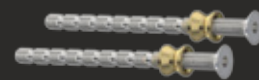
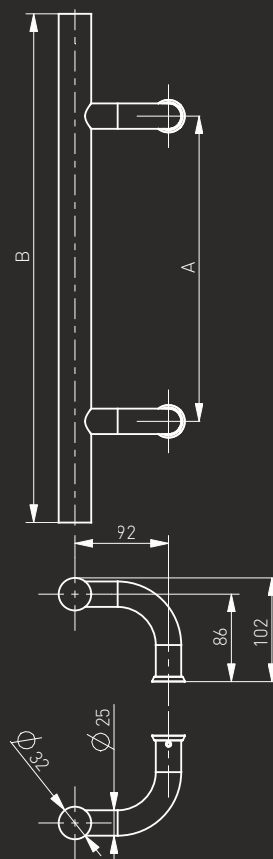
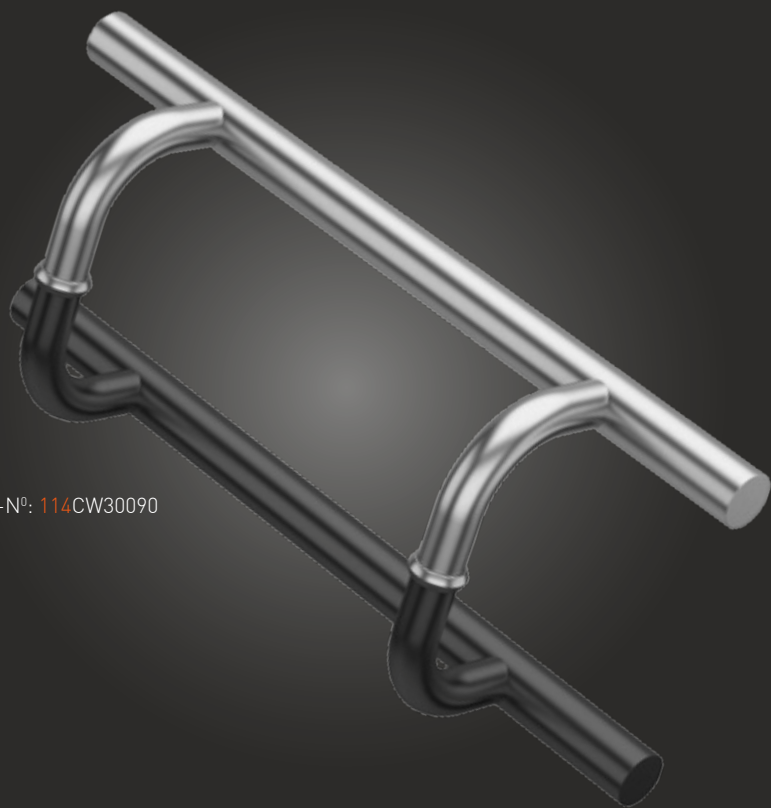

A	B
300	500
450	650
600	800
1200	1400
1300	1800

-Nº: 104CW30090

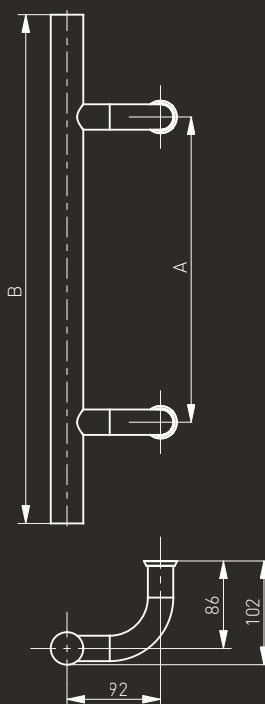

-Nº: 10400000000

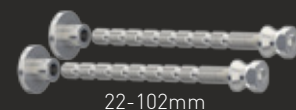

22-102mm

L	-Nº
35	10400003500
45	10400004500
55	10400005500

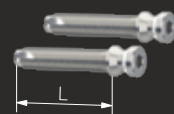

-Nº: 10400000012



Pochwył ze stali nierdzewnej "CW" (INOX)

A dark grey door with a silver handle and lock, set against a red brick wall. The door features a vertical silver handle and a silver lock mechanism. The brick wall is visible on the left side of the image.

Medos
PR



-Nº: 114PR30045

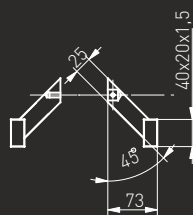
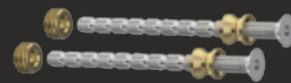
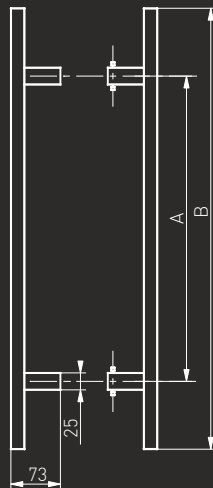

A	B
300	500
450	650
600	800
1200	1400
1300	1800

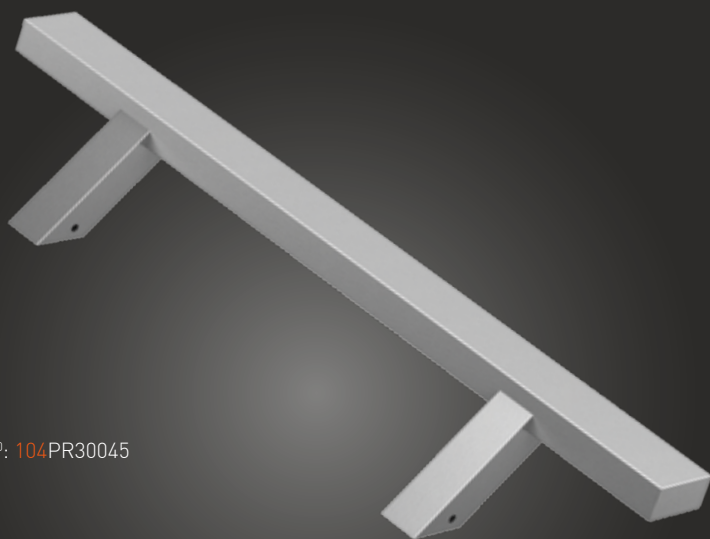

-Nº: 104PR30045

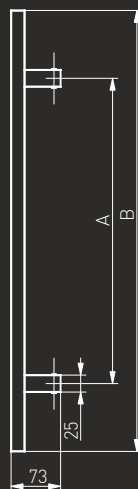

-Nº: 10400000000

22-102mm

L	-Nº
35	10400003500
45	10400004500
55	10400005500

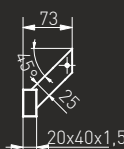
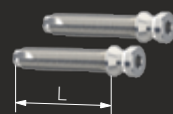

-Nº: 10400000012



Pochwył ze stali nierdzewnej "PR" (INOX)

Szczotkowany / Brushed / Brossée / Шлифованная

Pochwył drzwiowy / Pull handle / Barre de tirage / Офисная ручка



Medos
PR



-N^o: 114PR30090

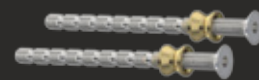
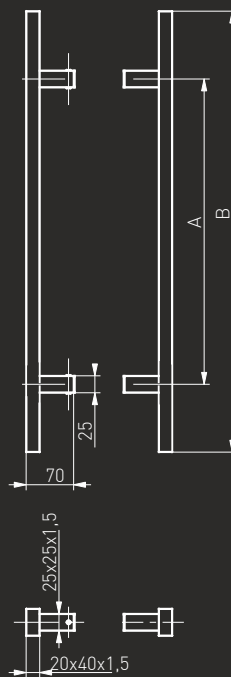

A	B
300	500
450	650
600	800
1200	1400
1300	1800

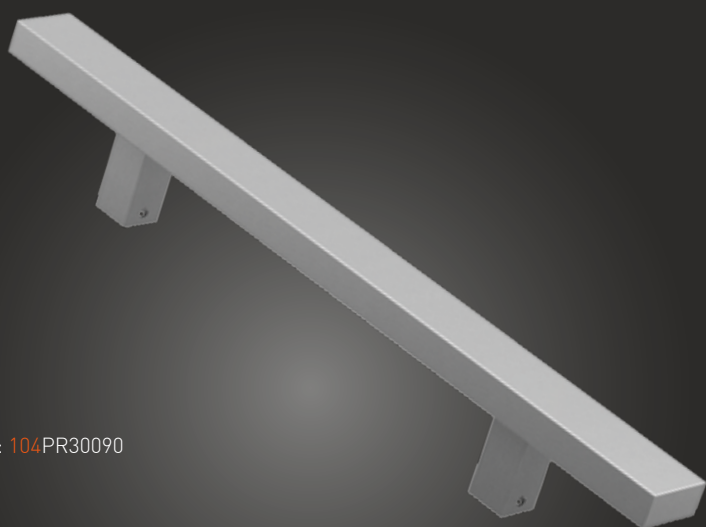

-N^o: 104PR30090

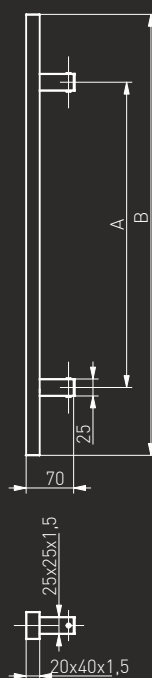

-N^o: 10400000000

22-102mm

L	-N ^o
35	10400003500
45	10400004500
55	10400005500

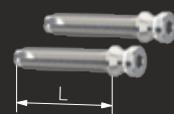

-N^o: 10400000012



Pochwyt ze stali nierdzewnej "PR" (INOX)

Szczotkowany / Brushed / Brossée / Шлифованная

Pochwyt drzwiowy / Pull handle / Barre de tirage / Офисная ручка



Medos
KW

-Nº: 114KW30045

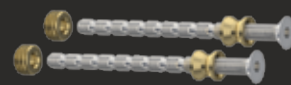
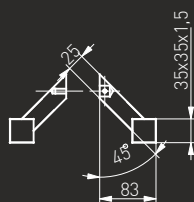
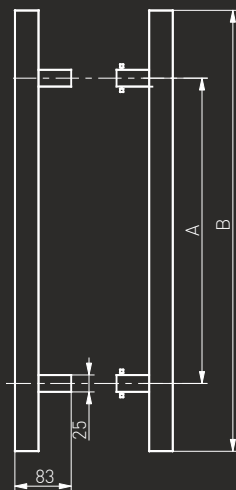
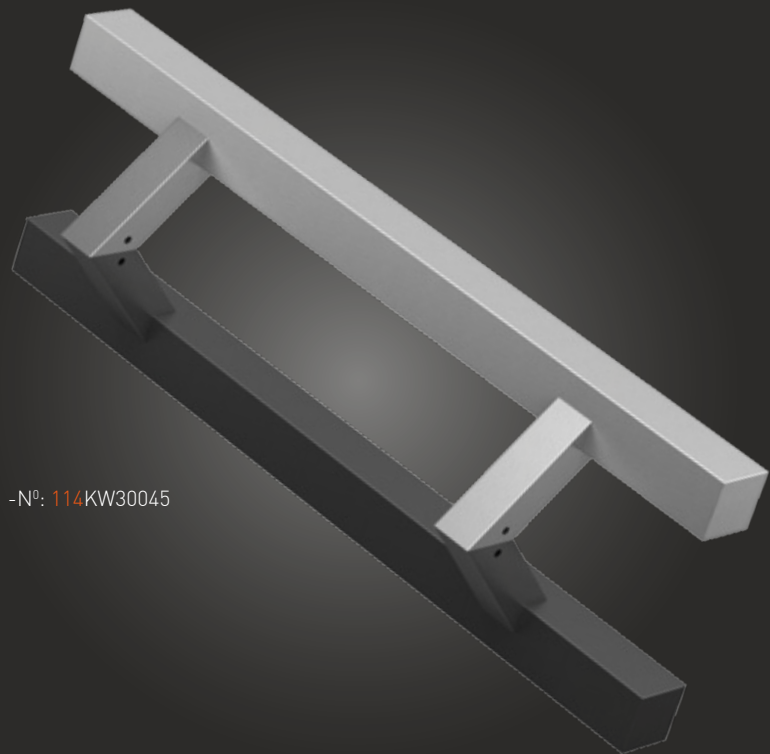

A	B
300	500
450	650
600	800
1200	1400
1300	1800

-Nº: 104KW30045

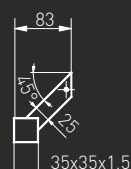
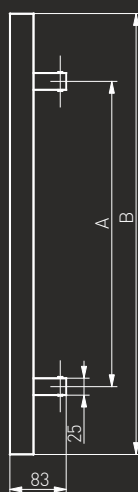
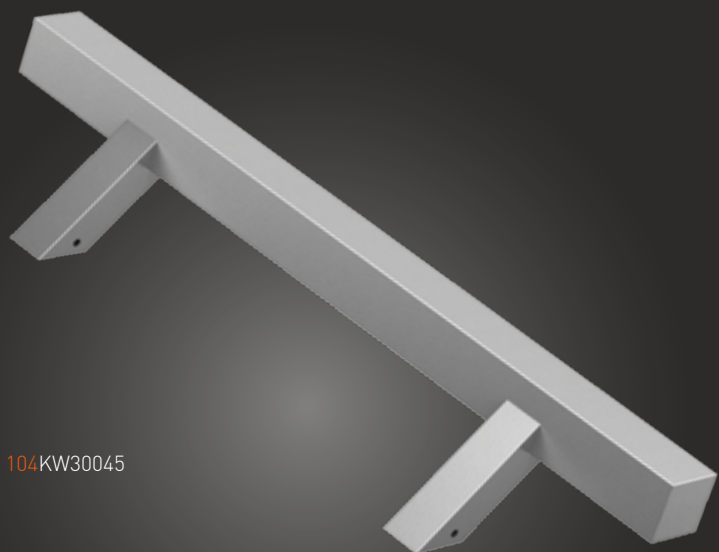

-Nº: 10400000000

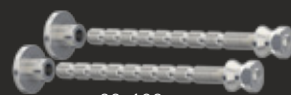

22-102mm

L	-Nº
35	10400003500
45	10400004500
55	10400005500

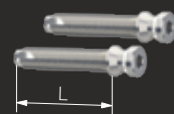

-Nº: 10400000012



Pochwył ze stali nierdzewnej "KW" (INOX)

Szczotkowany / Brushed / Brossée / Шлифованная

Pochwył drzwiowy / Pull handle / Barre de tirage / Офисная ручка



Medos
KW

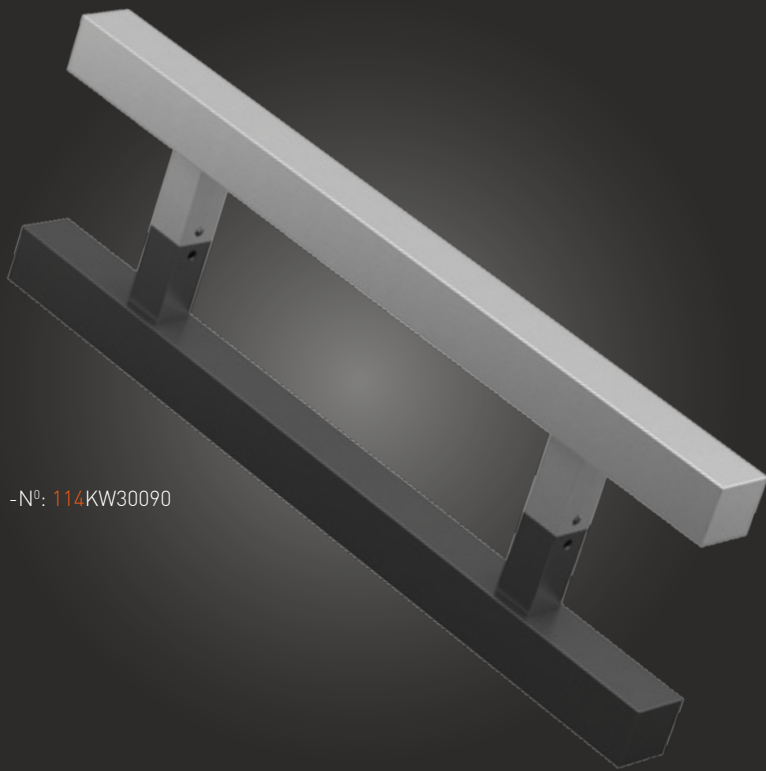

-Nº: 114KW30090

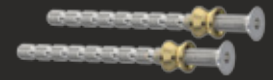
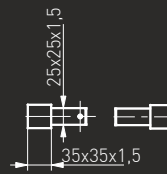
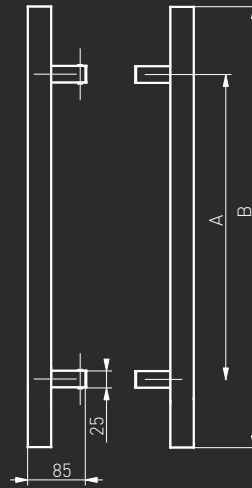

A	B
300	500
450	650
600	800
1200	1400
1300	1800

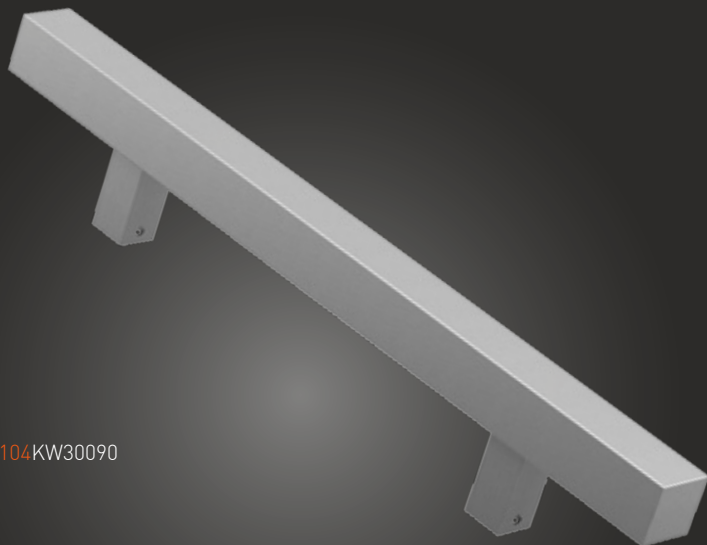

-Nº: 104KW30090

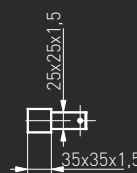
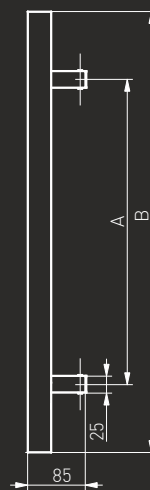

-Nº: 10400000000

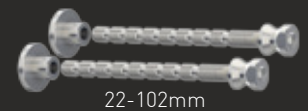

22-102mm

L	-Nº
35	10400003500
45	10400004500
55	10400005500

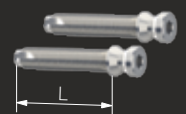

-Nº: 10400000012



Pochwyt ze stali nierdzewnej "KW" (INOX)

Szczotkowany / Brushed / Brossée / Шлифованная

Pochwyt drzwiowy / Pull handle / Barre de tirage / Офисная ручка



Medos

01

-Nº: 114SILV3001

-Nº: 104SILV3001

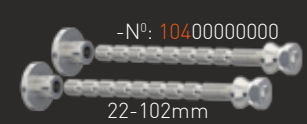
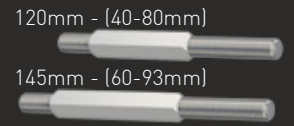
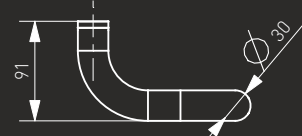
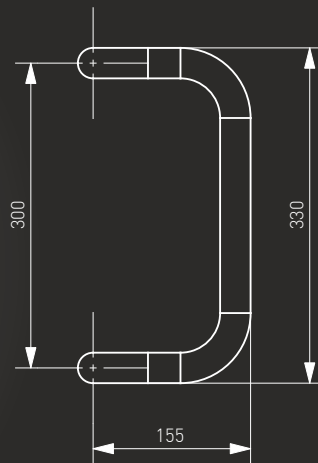
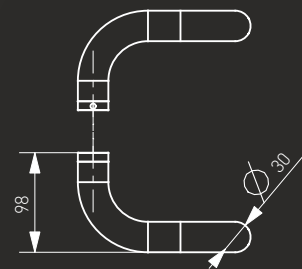
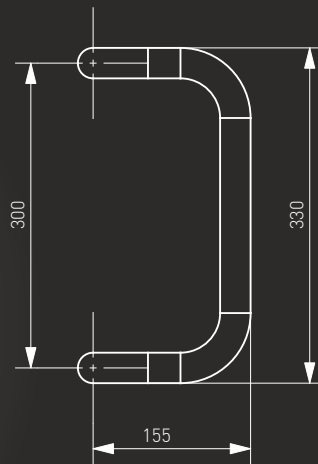

Pochwył aluminiowy "01"

Pochwył drzwiowy / Pull handle / Barre de tirage / Офисная ручка



Medos

02

120mm - (40-80mm)

145mm - (60-93mm)

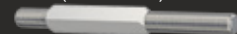

-Nº: 114SILV3002

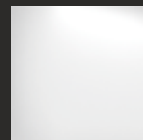
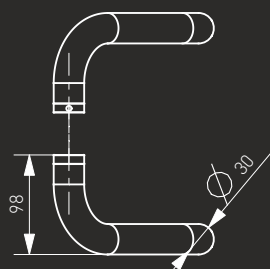
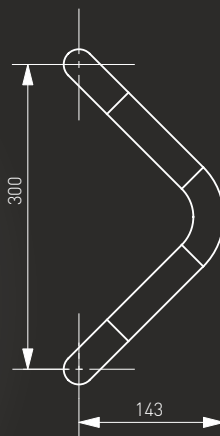

RAL 9016

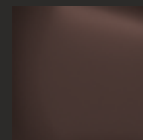

RAL 8019

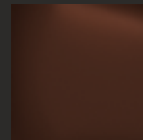

RAL 8017

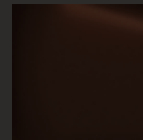

RAL 8077

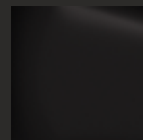

RAL 9005

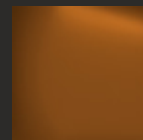

RAL 8003

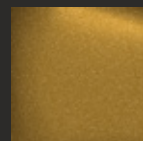

GOLD

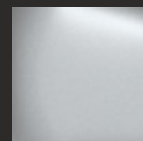

SILVER



TITAN

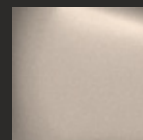

SATIN



-Nº: 104SILV3002

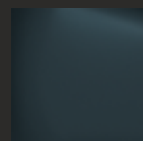
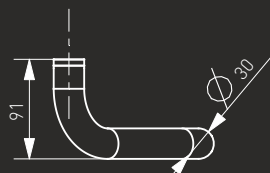
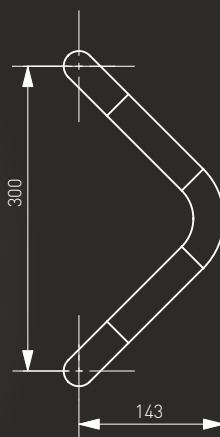

RAL 7016

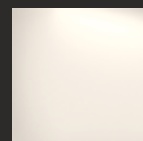

RAL 9001

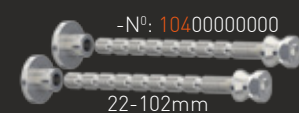

-Nº: 10400000000

22-102mm

-Nº: 10400000001



L	-Nº
35	10400003500
45	10400004500
55	10400005500



-Nº: 10400000012



Pochwył aluminiowy "02"

Pochwył drzwiowy / Pull handle / Barre de tirage / Офисная ручка



Medos

03

120mm - (40-80mm)

145mm - (60-93mm)

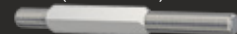

-Nº: 114SILV3003

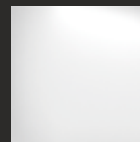
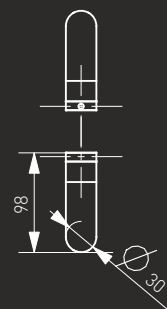
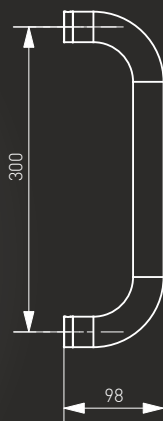

RAL 9016

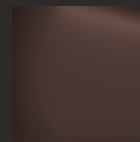

RAL 8019

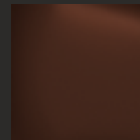

RAL 8017

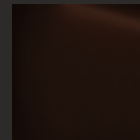

RAL 8077

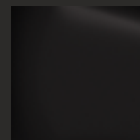

RAL 9005

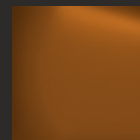

RAL 8003

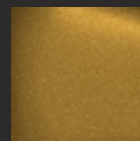

GOLD

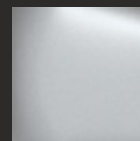

SILVER



TITAN

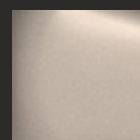

SATIN



-Nº: 104SILV3003

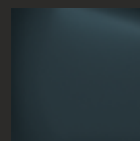
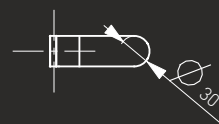
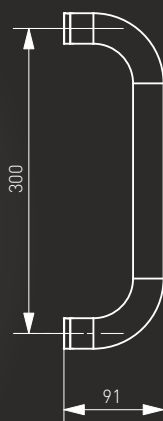

RAL 7016

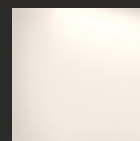

RAL 9001

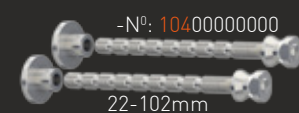

-Nº: 10400000000

22-102mm

-Nº: 10400000001



L -Nº

35 10400003500

45 10400004500

55 10400005500

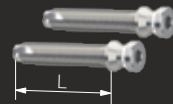

-Nº: 10400000012



Pochwyt aluminiowy "03"

Pochwyt drzwiowy / Pull handle / Barre de tirage / Офисная ручка



Medos

04

-Nº: 114SILV3004

-Nº: 104SILV3004

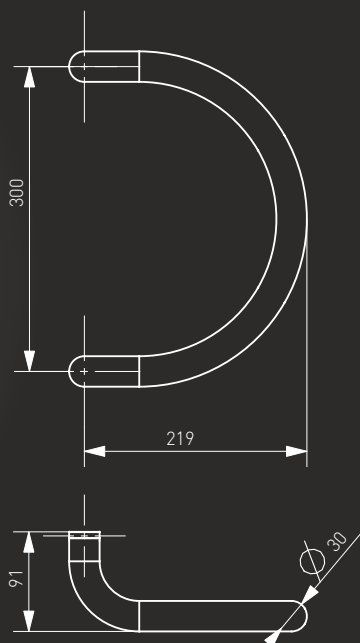
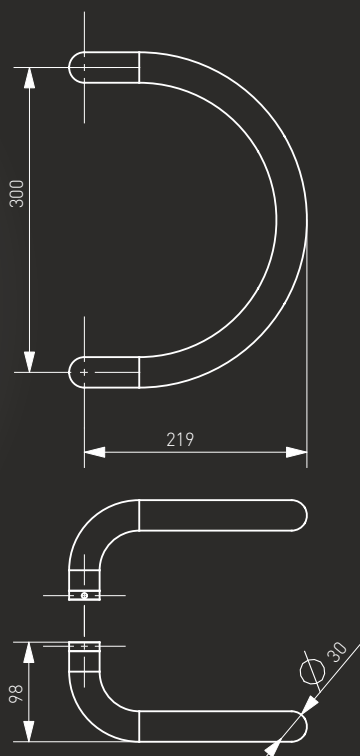

120mm - (40-80mm)

145mm - (60-93mm)



Pochwyt aluminiowy "04"

Pochwyt drzwiowy / Pull handle / Barre de tirage / Офисная ручка

-N°: 151INOX0000

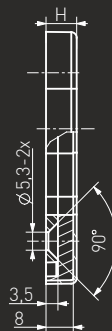
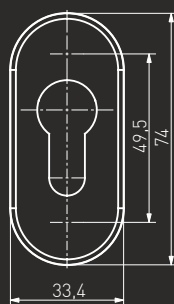

H
6,5
9

-N°: 150INOX0000

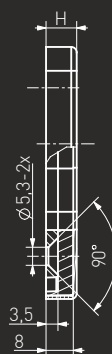
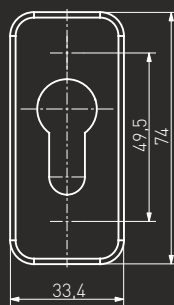

Szyld ze stali nierdzewnej

Szczotkowany / Brushed / Brossée / Шлифованная

Szyld drzwiowy / Door rosette / Rosace / Накладка под цилиндр

-N°: 151SILV0000

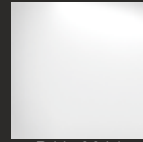
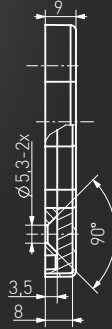
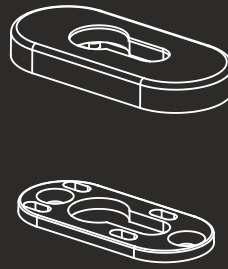
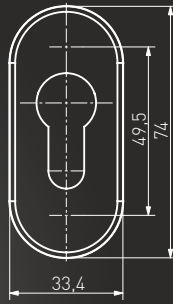

RAL 9016



RAL 8019

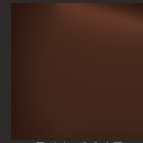

RAL 8017



RAL 8077

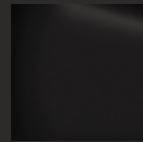

RAL 9005



RAL 8003

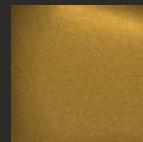

GOLD



SILVER

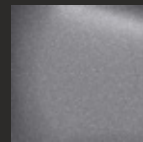

TITAN

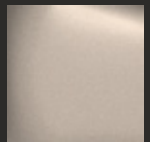

SATIN

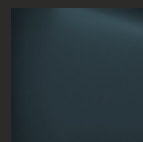

RAL 7016

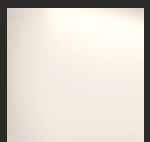

RAL 9001

-N°: 150SILV0000

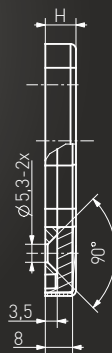
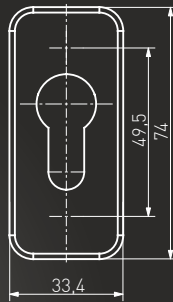

Szyld aluminiowy

Szyld drzwiowy / Door rosette / Rosace / Накладка под цилиндр

Montaż / Assembly / Montage / Монтаж

Jednostronny 45°
Single sided 45°
Unilatéral 45°
Односторонний 45°

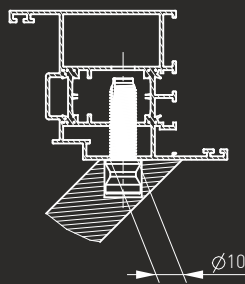

Jednostronny 45°
Single sided 45°
Unilatéral 45°
Односторонний 45°

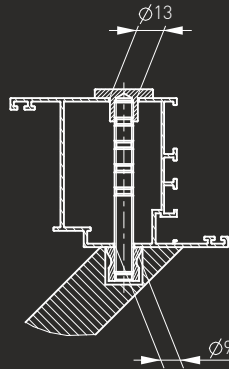

Dwustronny 45° - szkło
Double sided 45° - glass
Bilatéral 45° - verre
Двусторонний 45° - стекло

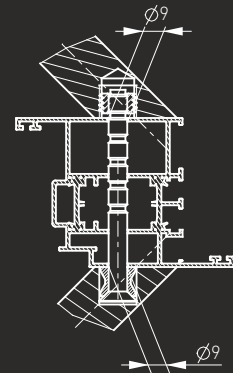

Dwustronny 45° - szkło
Double sided 45° - glass
Bilatéral 45° - verre
Двусторонний 45° - стекло

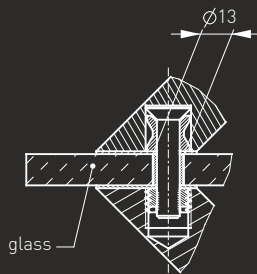

Dwustronny 90° - szkło
Double sided 90° - glass
Bilatéral 90° - verre
Двусторонний 90° - стекло

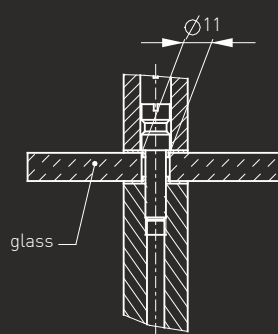

Dwustronny 90° - szkło
Double sided 90° - glass
Bilatéral 90° - verre
Двусторонний 90° - стекло

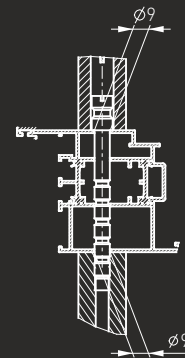

Jednostronny 90°
Single sided 90°
Unilatéral 90°
Односторонний 90°

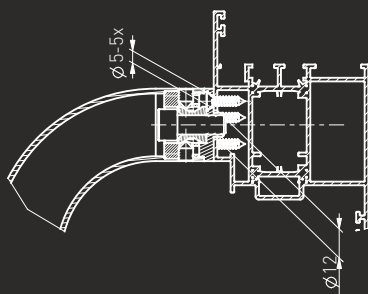

Jednostronny 90°
Single sided 90°
Unilatéral 90°
Односторонний 90°

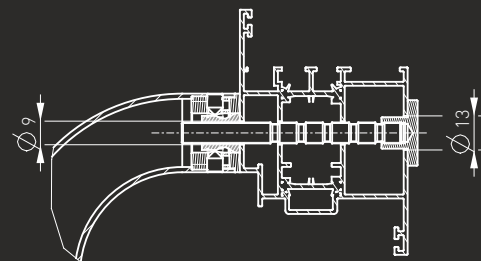

Jednostronny 90°
Single sided 90°
Unilatéral 90°
Односторонний 90°

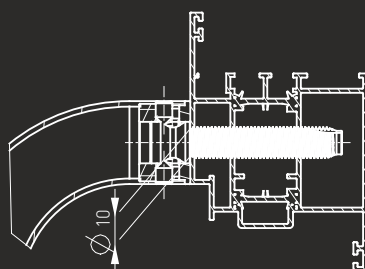

Dwustronny 90° - szkło
Double sided 90° - glass
Bilatéral 90° - verre
Двусторонний 90° - стекло

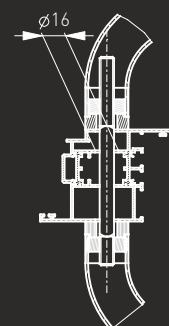



DZIAŁ SPRZEDAŻY KRAJOWEJ

PL

Andrzej Lewoń

Specjalista ds. Marketingu i Handlu
Tel. +48 56 691 20 59
Kom. +48 513 193 938
andrzej@medos.pl

Jakub Sokołowski

Specjalista ds. Marketingu i Handlu
Tel. +48 56 691 20 58
Kom. +48 505 079 162
kuba@medos.pl

Tomasz Poniatoński

Specjalista ds. Marketingu i Handlu
Tel. +48 56 691 20 64
Kom. +48 508 186 242
tomek@medos.pl

Zbigniew Myszka

Specjalista ds. Marketingu i Handlu
Tel. +48 56 691 20 75
Kom. +48 56 622 74 11
zbyszek@medos.pl

Przemysław Lasowski

Specjalista ds. Marketingu i Handlu
Tel. +48 56 691 20 75
Kom. +48 601 277 142
przemek@medos.pl

INTERNATIONAL SALES

Łukasz Napieralski

International Sales Director
Tel. +48 56 691 20 56
Mob. +48 515 248 576
Fax +48 56 691 20 50
lukasz@medos.pl



ENG ES

Adam Szulc

Export Manager
Tel. +48 56 691 30 97
Mob. +48 609 318 148
Fax +48 56 691 20 50
as@medos.pl



ENG

Andrzej Mojsiewicz

Export Manager
Tel. +48 56 691 20 70
Mob. +48 502 718 288
andrzej.m@medos.pl



RU LT

Ewa Bartoszewska

Export Manager
Mob. +48 601 945 737
ewa.b@medos.pl



RU ENG

Grażyna Kierska

Export Manager
Tel. +48 56 662 74 14
Mob. +48 607 856 654
gk@medos.pl



FR IT



 Medos

MEDOS

Marian Buławka, Ewa Buławka sp.j.
ul. Magazynowa 3
86-200 Chętno / Polska

NIP: 875-10-02-162
REGON: 870568014

medos@medos.pl
www.medos.pl

tel.: +48 (56) 691 20 57-59
tel/fax: +48 (56) 691 20 63
fax: +48 (56) 691 20 50